

Total solder points: 169 + 99 + 67
Difficulty level: *beginner* 1 2 3 4 5 *advanced*

TEMPERATURE CONTROLLER

K6002

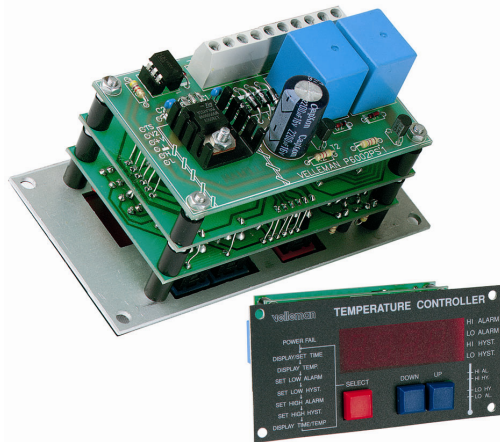

Unlike a normal thermostat, this kit has two outputs, one for "high" alarm and one for "low" alarm.

Specifications

- Accuracy: +/- 0.1°C.
- Relay outputs: 5A/220VAC change-over contact.
- Read out from -40°C to +150°C (together with K6001).
- 24 hour clock (50Hz mains frequency accuracy).
- Alarm setting from -50°C to +154°C.
- Power supply: 9VAC/300mA

Unlike a normal thermostat this Kit has two outputs, one for a "high" alarm e.g. to switch on a fan or the air conditioning (or to control the temperature of the freezer), and one for a "low" alarm e.g. to switch on the central heating. Both "alarms" are adjustable separately, each with its own hysteresis.

For measuring the temperature you need kit K6001 (1 piece supplied with the kit), which will convert the temperature into a pulse width (a sort of alternating voltage). This has as an advantage that the sensor can be installed at a distance, without the measuring being disturbed by external noise.

This allows you, by using a switch, to monitor several sensors with only one controller (e.g. temperature outside, in the living-room, in the cellar).

Although the controller is more suited for professional applications, it can also be used as an ordinary thermostat. Especially for this group of users a clock has been built in, which at choice is visible either constantly or alternately with the temperature.

Thanks to the menu structure, adjusting the controller is very simple. In order to keep the housing or mounting simple and compact, a system consisting of three modules, together with a front panel has been opted for.

Features:

- ☑ High and low alarm output with LED indication.
- ☑ Temperature read out in degrees Celsius.
- ☑ Hysteresis adjustable per alarm.
- ☑ Separated opto-coupler sensor input (for K6001).

Specifications:

- Accuracy: +/- 0.1°C.
- Relay outputs: 5A/220VAC change-over contact.
- Read out from -40°C to +150°C (together with K6001).
- 24 hour clock (50Hz mains frequency accuracy).
- Alarm setting from -50°C to +154°C.
- Power supply: 9VAC/300mA

1. Assembly (Skipping this can lead to troubles !)

Ok, so we have your attention. These hints will help you to make this project successful. Read them carefully.

1.1 Make sure you have the right tools:

- A good quality soldering iron (25-40W) with a small tip.
- Wipe it often on a wet sponge or cloth, to keep it clean; then apply solder to the tip, to give it a wet look. This is called 'thinning' and will protect the tip, and enables you to make good connections. When solder rolls off the tip, it needs cleaning.
- Thin raisin-core solder. Do not use any flux or grease.
- A diagonal cutter to trim excess wires. To avoid injury when cutting excess leads, hold the lead so they cannot fly towards the eyes.
- Needle nose pliers, for bending leads, or to hold components in place.
- Small blade and Phillips screwdrivers. A basic range is fine.

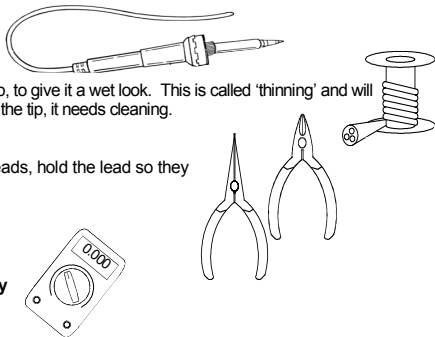

 **For some projects, a basic multi-meter is required, or might be handy**

1.2 Assembly Hints :

- ⇒ Make sure the skill level matches your experience, to avoid disappointments.
- ⇒ Follow the instructions carefully. Read and understand the entire step before you perform each operation.
- ⇒ Perform the assembly in the correct order as stated in this manual
- ⇒ Position all parts on the PCB (Printed Circuit Board) as shown on the drawings.
- ⇒ Values on the circuit diagram are subject to changes.
- ⇒ Values in this assembly guide are correct*
- ⇒ Use the check-boxes to mark your progress.
- ⇒ Please read the included information on safety and customer service

* Typographical inaccuracies excluded. Always look for possible last minute manual updates, indicated as 'NOTE' on a separate leaflet.

1.3 Soldering Hints :

1- Mount the component against the PCB surface and carefully solder the leads

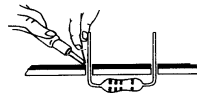

2- Make sure the solder joints are cone-shaped and shiny

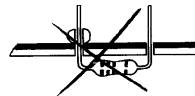
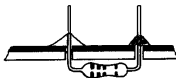

3- Trim excess leads as close as possible to the solder joint

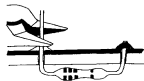

REMOVE THEM FROM THE TAPE ONE AT A TIME !

**AXIAL COMPONENTS ARE TAPED IN THE
CORRECT MOUNTING SEQUENCE !**

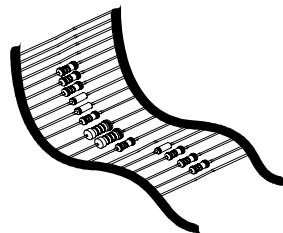

 You will find the colour code for the resistances and the LEDs in the HALG (general manual) and on our website: <http://www.velleman.be/common/service.aspx>

1.0 Assembly of the power supply module P6002PS

1. Diodes. Watch the polarity !

- D1 : 1N4148
- D2 : 1N4148
- D3 : 1N4148

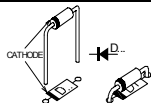

2. 1/4W Resistors

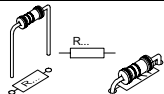

- R1 : 4K7 (4 - 7 - 2 - B)
- R2 : 4K7 (4 - 7 - 2 - B)
- R3 : 47K (4 - 7 - 3 - B)

3. Diodes. Watch the polarity !

- D4 : 1N4007
- D5 : 1N4007
- D6 : 1N4007
- D7 : 1N4007

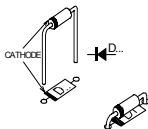

4. IC socket. Watch the position of the notch!

- IC1 : 6p

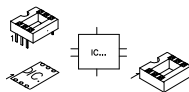

5. Capacitors

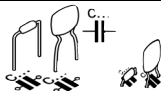

- C1 : 100nF (104)
- C2 : 100nF (104)

6. Transistors.

- T1 : BC547B
- T2 : BC547B

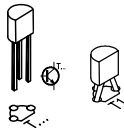

7. Terminal blocks

- J1 : 2 x 2p
- J2 : 3 x 2p

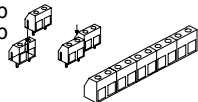

8. Electrolytic Capacitor. Watch the polarity !

- C3 : 2200µF

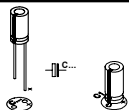

9. Relays

- RY1 : VR15M121C (12V/15A - 1C)
- RY2 : VR15M121C (12V/15A - 1C)

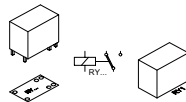

10. Voltage regulator.

□ VR1 : UA7805

First bend the connections of the regulator at an angle of 90°, so that the fixing hole corresponds with the pcb, then fix the regulator along with the cooling plate onto the pcb using an M3 bolt and a nut.

Now you may solder the connections of the regulator.

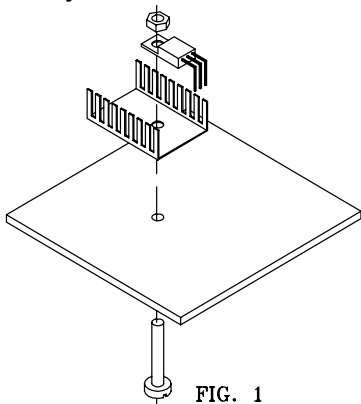

11. IC. Watch the position of the notch!

□ IC1 : TIL111



2.0 Assembly of the processor module P602UP

1. Jumper wire

□ J : 3x

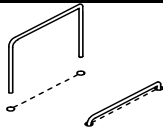

2. Diode. Watch the polarity !

□ D8 : 1N4148
□ D9 : 1N4148

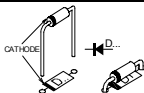

3. 1/4W Resistors

□ R4 : 4K7 (4-7-2-B)
□ R5 : 4K7 (4-7-2-B)
□ R6 : 4K7 (4-7-2-B)
□ R7 : 4K7 (4-7-2-B)
□ R8 : 4K7 (4-7-2-B)

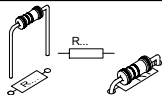

□ R9 : 1K (1-0-2-B)
□ R10 : 47K (4-7-3-B)
□ R11 : 47K (4-7-3-B)
□ R12 : 47K (4-7-3-B)
□ R13 : 47K (4-7-3-B)
□ R14 : 47K (4-7-3-B)

4. IC socket. Watch the position of the notch!

□ IC2 : 28p

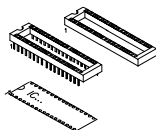

5. Capacitors

□ C4 : 18pF (18)
□ C5 : 18pF (18)
□ C6 : 10nF (103)
□ C8 : 100nF (104)



☞ Do not mount C7 !!!

6. Crystal.

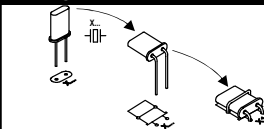

□ X1 : 4,1943 MHz.

7. Transistor.

□ T3 : BC547B

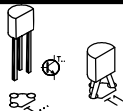

8. IC. Watch the position of the notch!

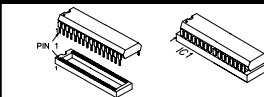

□ IC1 : VK6002 (programmed PIC16C55A-04)

3.0 Assembly of the display module P6002D

1. 1/4W Resistors

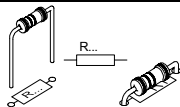

- R35 : 4K7 (4 - 7 - 2 - B)
- R36 : 4K7 (4 - 7 - 2 - B)
- R37 : 4K7 (4 - 7 - 2 - B)
- R38 : 4K7 (4 - 7 - 2 - B)

2. IC socket.

Fit a 40-pin IC-socket at the place of DY1 through DY4.

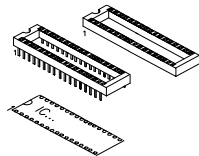

3. Transistors.

- T4 : BC547B
- T5 : BC547B
- T6 : BC547B
- T7 : BC547B
- T8 : BC547B
- T9 : BC547B
- T10: BC547B
- T11: BC547B
- T12: BC547B
- T13: BC547B

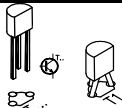

- T14: BC516
- T15: BC516
- T16: BC516
- T17: BC516

4. 1/4W Resistors



- R15 : 100 (1 - 0 - 1 - B)
- R16 : 100 (1 - 0 - 1 - B)

- R17 : 100 (1 - 0 - 1 - B)
- R18 : 100 (1 - 0 - 1 - B)
- R19 : 100 (1 - 0 - 1 - B)
- R20 : 100 (1 - 0 - 1 - B)
- R21 : 100 (1 - 0 - 1 - B)
- R22 : 100 (1 - 0 - 1 - B)

- R23 : 270 (2 - 7 - 1 - B)
- R24 : 270 (2 - 7 - 1 - B)

- R25 : 4K7 (4 - 7 - 2 - B)
- R26 : 4K7 (4 - 7 - 2 - B)
- R27 : 4K7 (4 - 7 - 2 - B)
- R28 : 4K7 (4 - 7 - 2 - B)
- R29 : 4K7 (4 - 7 - 2 - B)
- R30 : 4K7 (4 - 7 - 2 - B)
- R31 : 4K7 (4 - 7 - 2 - B)
- R32 : 4K7 (4 - 7 - 2 - B)
- R33 : 4K7 (4 - 7 - 2 - B)
- R34 : 4K7 (4 - 7 - 2 - B)

5. Displays

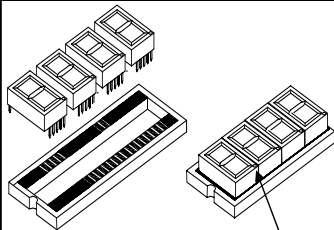

Decimal point

- DY1
- DY2
- DY3
- DY4

☞ Pay attention to the position of the decimal point !

6. LEDs. Watch the polarity!

- LD1
- LD2
- LD3
- LD4

Red

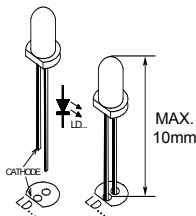

☞ Take care that the LED's do not overtop the displays !

7. Push button.

- SW1
- SW2
- SW3

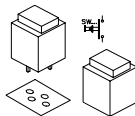

4.0 ASSEMBLY

Solder at the through connection points A0,S3,A1,A2,etc... (fig 2.0); D,C,E,etc... (fig 3.0) of the display module (**P6002D**), a wire jumper at the solder side, so that you can connect them to the processor module (P6002UP) later on.

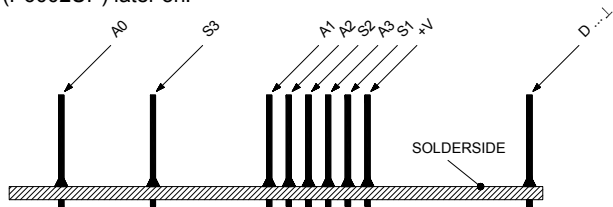

FIG. 2.0

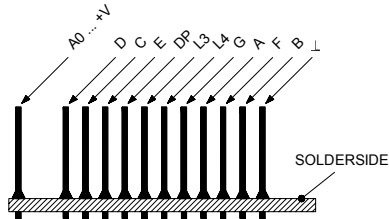

FIG. 3.0

Cut the free ends of the wire jumpers on the bias (see fig. 4.0); this makes passing through the other pcb easier.

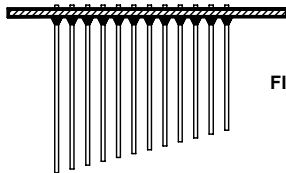
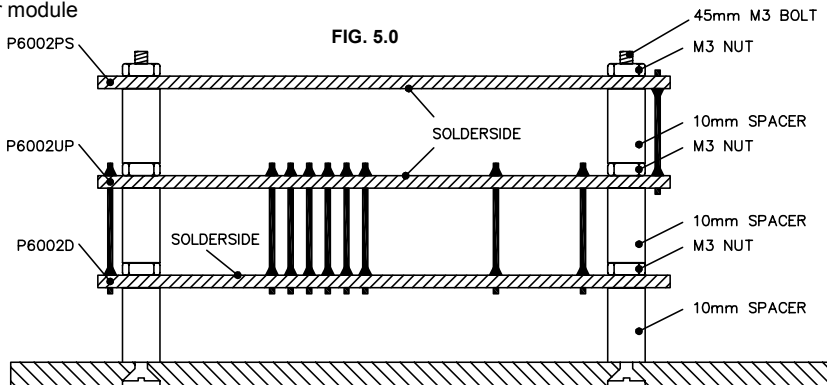

FIG. 4.0

Final assembly (fig 5.0):

Fit the front panel with four 45mm bolts, and push a 10mm distance tube on each bolt. Push the display module on the bolts up to the distance tubes and fix the module by means of four nuts (check if the displays are flush with the front side of the front panel). Push another four 10mm distance tubes on the bolts, followed by the processor module (with its components towards the front panel) and take care that the through connections are made. However don't solder them until the module has been fixed by means of four nuts. Now push another four 10mm distance tubes on the bolts followed by the supply module with its components at the back. Fix the module using four nuts and make the through connections TS,V2,+V etc... with the processor module



Then fit the push buttons with their caps (red for select-SW1), fig 6.0.

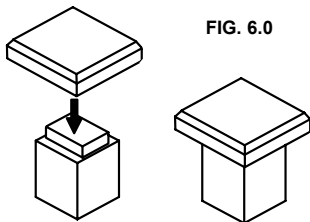

FIG. 6.0

Finally stick the front panel to the front plate.



Attention: keep the display window free!

5.0 ADJUSTMENT AND USAGE

Connect a 9VAC supply voltage to the terminals VA and VB. Now, provided everything is all right, the indication FAIL should be displayed (this will be the case after every interruption of the supply voltage), see figure 7.0. For the further test you need the sensor K6001.

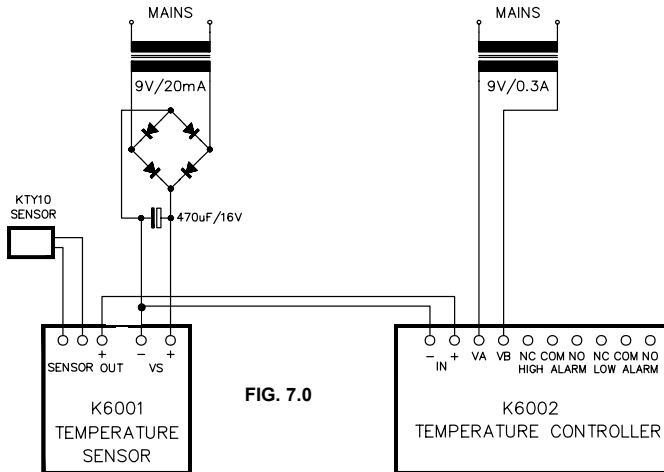



FIG. 7.0

 **REMARK :**

- The controller won't work (neither the clock) until the temperature sensor has been connected.
- Following very short power interruptions the controller may get locked up. Therefore leave a pause of about 10 seconds between switching the power off and switching it on again.

First switch the power supply of the controller off.

Connect the sensor output (OUT + and -) with the corresponding points (IN + and -) of the controller. (don't forget to connect the supply voltage of the sensor!)

 **ATTENTION:** The power supply of the sensor K6001 **MUST** be kept apart from the one of the controller. **NEVER** connect both power supplies together.

Now switch the power supply of the controller on. This causes the indication FAIL to be redisplayed. By now pushing SELECT repeatedly, you can call the different indications onto the display one after another. The different time and alarm settings then can be changed by pressing the UP or DOWN button.

 **REMARK:** To avoid contact bouncing, the push buttons won't react immediately, but only after about 0.5 seconds.

To pass to the next or previous step, push the button shortly.

To go through the menu quickly, keep the button pressed.

Sequence of the menus (see also fig. 8.0) :

- 1) TIME indication and setting
- 2) TEMPERATURE indication
- 3) LOW ALARM setting
- 4) LOW ALARM HYSTERESIS setting
- 5) HIGH ALARM setting
- 6) HIGH ALARM HYSTERESIS setting
- 7) ALTERNATELY TIME/TEMPERATURE indication

Pushing the button again causes the TIME to be redisplayed, etc... .

REMARK:

When going through the different alarm settings, at every single step the corresponding LED is lit, where the relay belonging to the alarm in question remains "OFF". So, the alarms will only react if the controller is in menu 1, 2 or 7. As soon as one of the alarm values is reached, the corresponding indication LED starts flashing and the relay belonging to it is driven on.

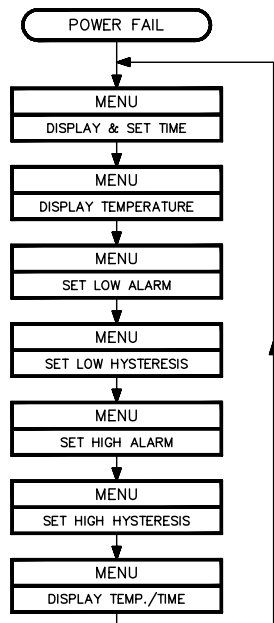

FIG. 8.0

Example of an alarm setting when using the kit to control a living-room heating combined with a cooling fan (or air-conditioning).

Desired temperature: 22°C

Highest temperature allowed: 26°C

Lowest temperature allowed: 19°C

Setting the alarms:

HIGH ALARM (to switch the fan on) : 26°C

HIGH HYSTERESIS (to switch the fan off) : 22°C

LOW ALARM (to switch the heating on) : 19°C

LOW HYSTERESIS (to switch the heating off) : 22°C

6.0 REMEDIES IN THE CASE OF MALFUNCTION CAUSED BY THE RELAYS

If the relays are used to switch alternating voltage, it may be necessary to suppress them.

Figure 9.0 shows how to suppress resistive loads (lamp, resistor, ...).

Figure 9.1 shows how to suppress inductive loads (transformer, motor, ...).

Figure 9.2 applies in case all the above solutions fail. In this last case an independantly feeded DC-relay is used, which is installed as close to the load as possible.

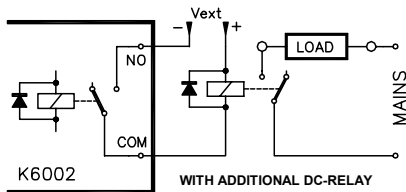
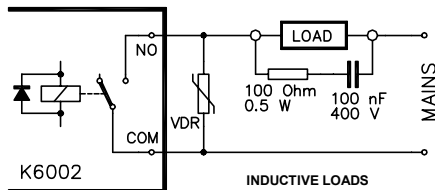
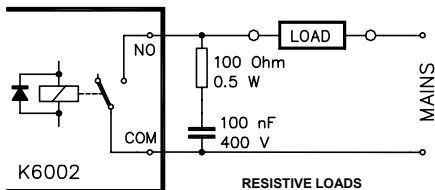

- ☞ **Pay attention to the diode which is fit ANTI-parallel with the coil, its cathode connected to the plus side, its anode connected to the minus side!**
- ☞ **This relay MUST be fed by a separate power supply.**

The VDR in fig. 9.1 must be suited for the voltage to be switched, e.g. Siemens SIOV S14K275 for use with a 220-240V mains, or S14K150 for a 110-125V mains.

The above remedies are general and consequently apply to any relay circuit.

7.0. SCHEMATIC DIAGRAM

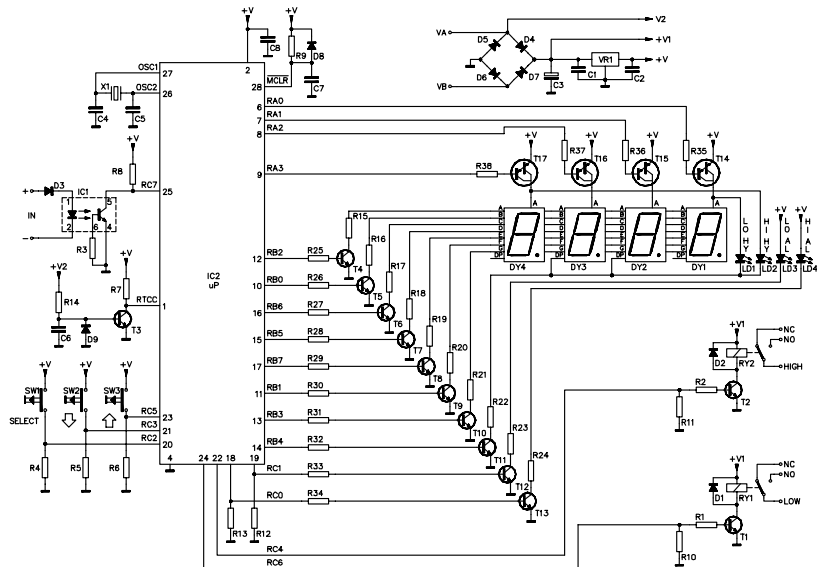

8.0. PCB

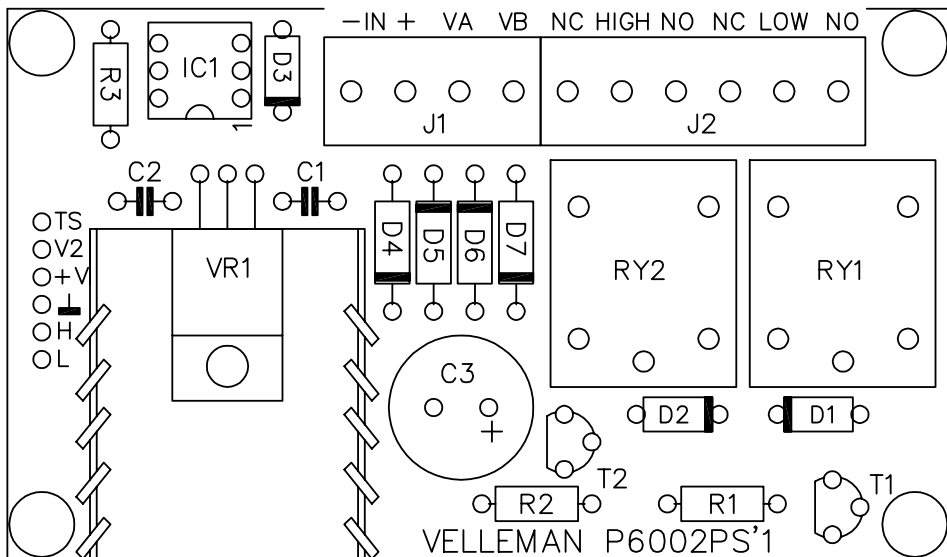

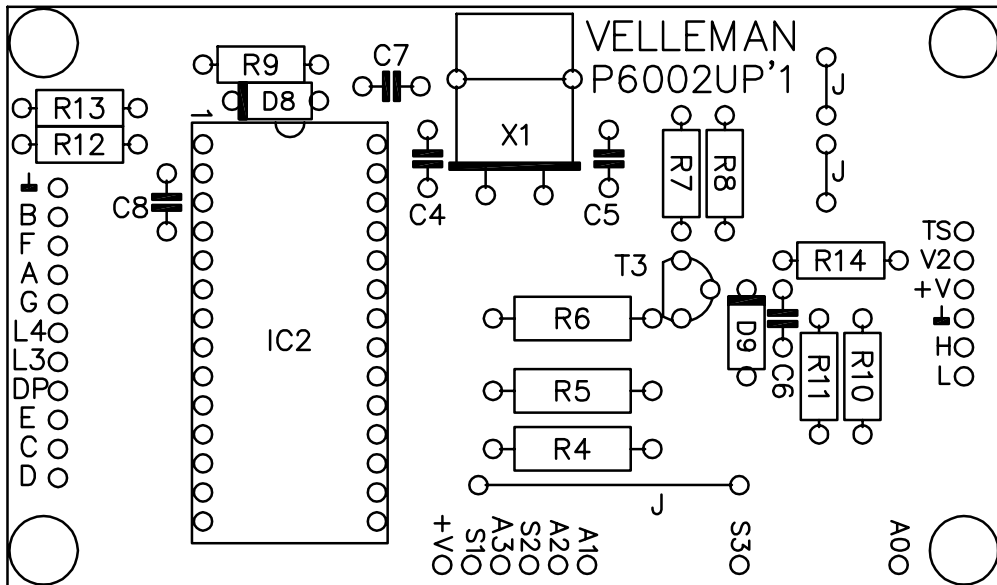

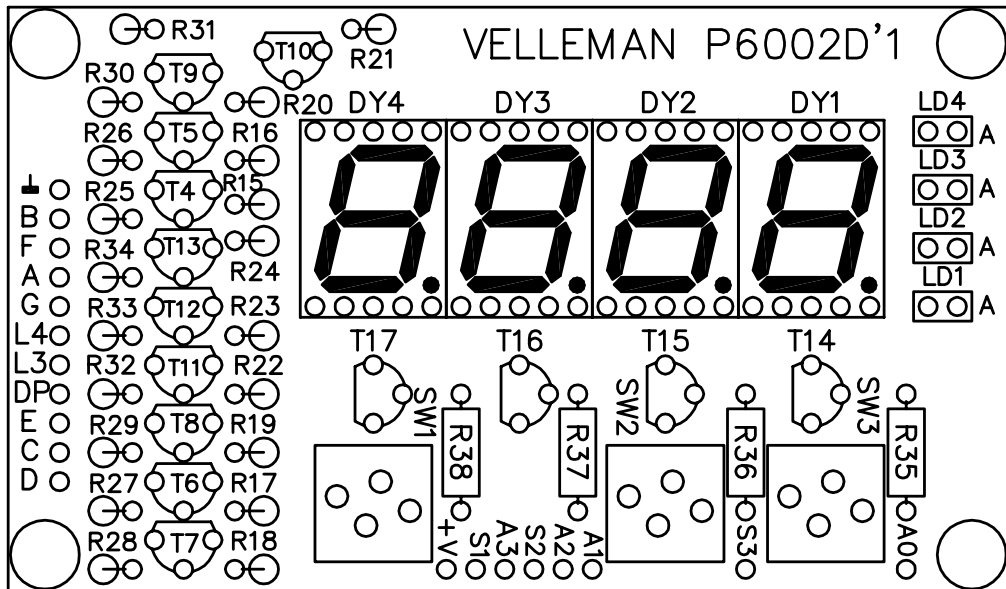

VELBUS
Velleman Home Automation System

**All appliances get intelligent, how about your home?
see our website : www.velbus.be**

Modifications and typographical errors reserved
 © Velleman nv.
 H6002IP - 2004 - ED1

VELLEMAN NV
Legen Heirweg 33, 9890 Gavere
Belgium - Europe

