

REV.	DATE	FILE No.
1.0	2011-5-10	AC27-5M

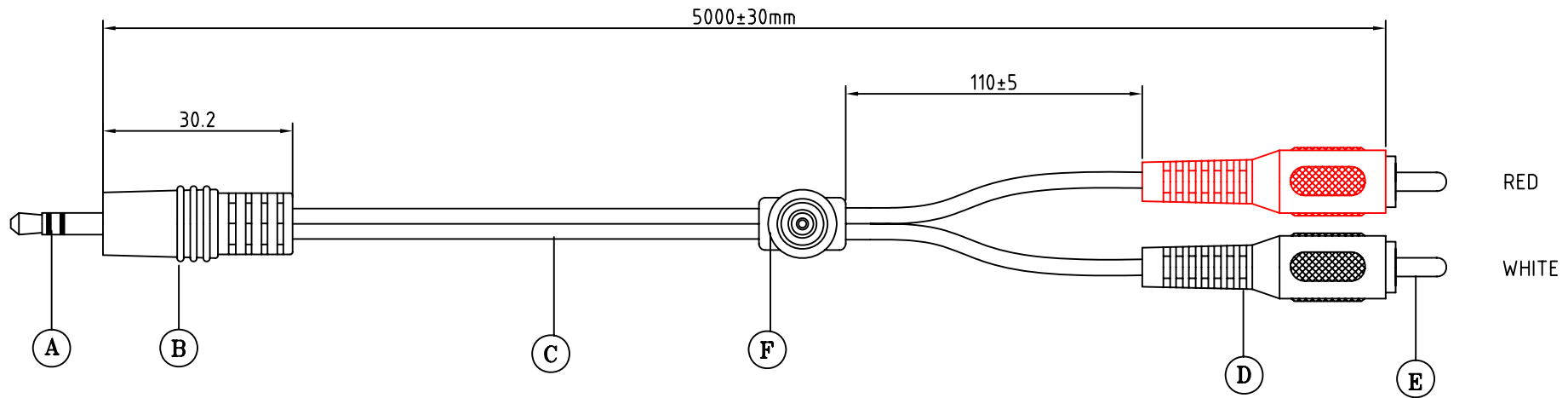

WIRING DIAGRAM

3.5MM ST.PLUG

RCA PLUG

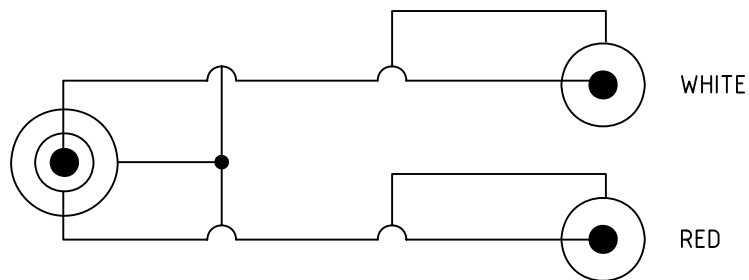

SPECIFICATION:

ITEM	PART NAME	MATERIAL	COLOR	QTY.
A	Y/E327 3.5MM STEREO PLUG	P.B.	NICKEL	1
B	MODEL TY-076 TYPE	PVC	BLACK	1
C	(0.12/10+0.12/24)X2F#2.6X5.2MM	PVC	BLACK	5M
D	MODEL TY-122 TYPE	PVC	RD/WT	2
E	Y/A023 RCA PLUG	P.B.	NICKEL	2
F	STOPPER MODEL TY-046 TYPE	PVC	BLACK	1

CUSTOMER: JESS LINK		Maxxtro [®]	
CUST. P/N: 105112			
S/O:	S/N:	PART No.: AC27-5M/BK-R	
DRAWING No.		PART NAME: 3.5 ST.PLUG TO 2XRCA PLUG	
DRAWN BY	Lingqi Meng	UNLESS OTHERWISE SPECIFIED, ALL DIMENSIONS ARE IN MM. TOLERANCE:DECIMAL .X ±0.1 .XX ±0.05 ANGLE ±1/2°	
CHECKED BY	Zhongjiao/Baifa		
APPROVED BY	Chenhan		
			SHEET 1 OF 1
			SCALE NO